

SAFETY EQUIPMENT

FABRICATION
FRANÇAISE

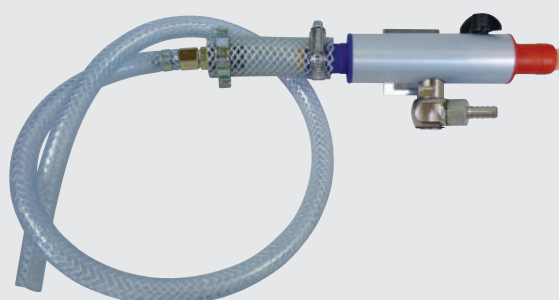
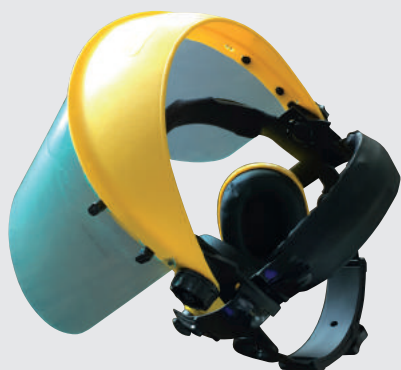

SANDBLASTING / GRITBLASTING

OPERATOR'S EQUIPMENT

- 1 - Filter holder **F 057**
- 2 - Cartridge **F 036**
- 3 - Helmet air hose
S 919 (5 m) - **S 917** (10 m)
S 918 (20 m)
- 4 - Helmet

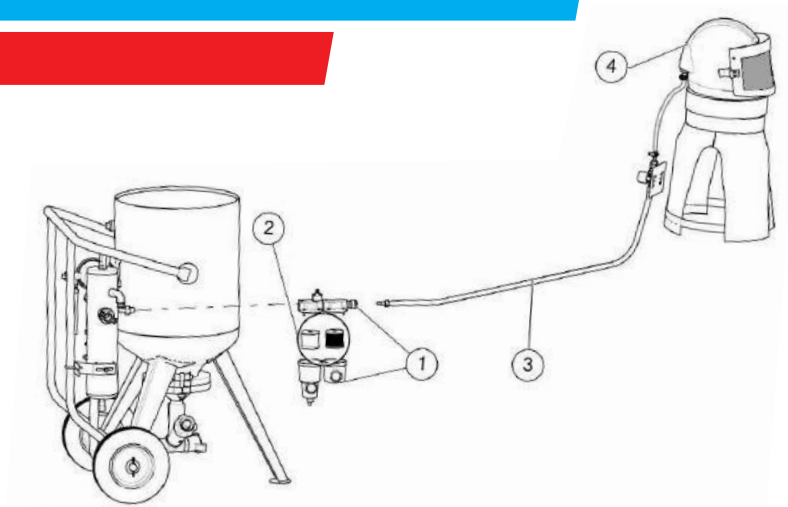

Helmet air filter



Air filter
F 057



Set of cartridges
for filter
F 036

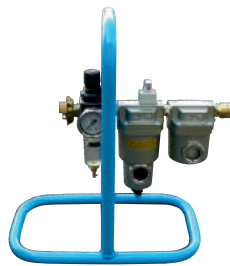

Combined filter
on support frame
F 056

Blast suit



S 166

Gloves



S 911



EC approved
S 171

Hot/Cold air conditioner

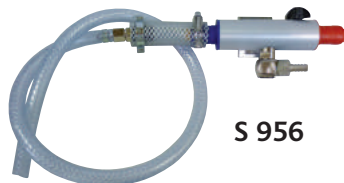

S 956

Helmet air hose

- S 919** : 5 m
- S 917** : 10 m
- S 918** : 20 m



EC approved
S 164



SANDBLASTING HELMETS

High resistance to abrasion - EC certification



BALI F 400
Panoramic window
Weight: 2,65 kg



BORNEO F 550
Rectangular window
Protective grid
Weight: 2,90 kg



TIMOR F 451
Panoramic window
Protective grid
Integrated LED lighting
Weight: 3,10 kg



SUMBA F 551
Square window
Protective grid
Integrated LED lighting
Weight: 3,20 kg



F 065
Disposable film
(per 50 units)
165 x 297 x 0,2



F 069
Rigid plastic screen
(per 5 units)
148 x 254 x 1,5



S 131
Visor with hearing
protection



S 133
Disposable screen
for S 131

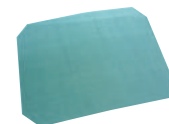

F 083
Protective grid
143 x 190

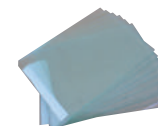

F 075
Outside glass screen
(per 10 units)
136 x 183 x 2

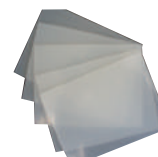

F 080
Inside plastic
screen (per 5 units)
136 x 181 x 3



F 041
Disposable paper
hood (50 units)

SAFETY EQUIPMENT FOR METALLIZATION

Aquilon Suit



Para-aramid fabric with fireproof treatment from neck to belt + aluminium coating foil on legs
M 260

Thor Helmet



High resistance
Ear protection
Long cape
M 200

Metallization gloves



Para-aramid fabric with aluminium foil coating on the upper part
M 261

Your nearest dealer:



LE SPÉCIALISTE

B.P. 23 - 69380 LOZANNE - FRANCE

Tél. : +33 (0)4 78 43 62 62

Fax : +33 (0)4 78 43 69 28

E-mail : acf@acf-france.com

www.acf-france.com